

Busability – Exploring Bus Transport

Green-Schools Travel Activity Sheets

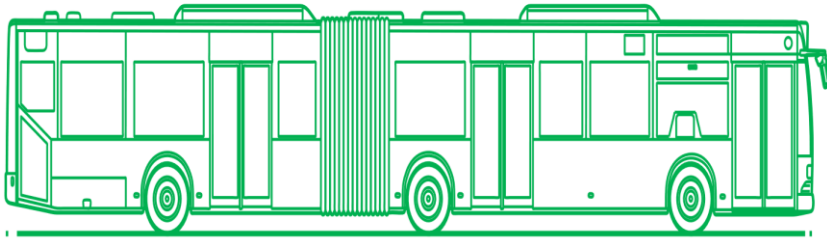

Articulated Bus

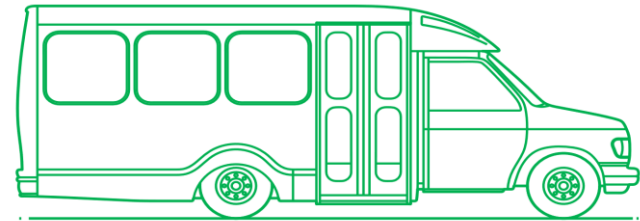

Mini-bus or Shuttle Bus

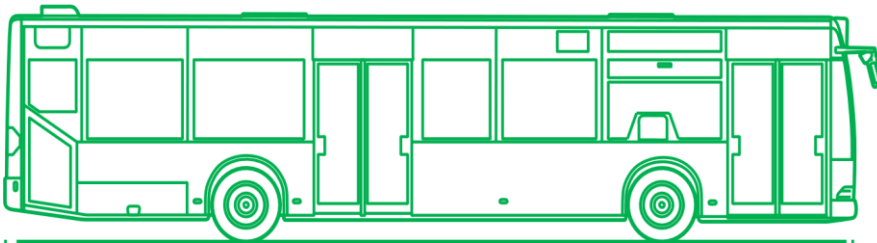

City Transit Bus

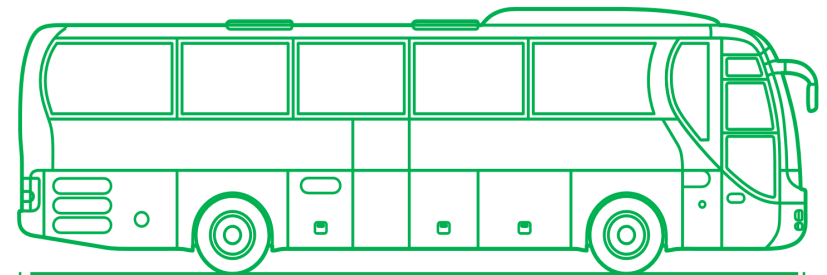

Coach Bus

Buses are designed to carry many passengers at the same time. There are many different types of buses used across the world. This resource presents four different types that you might see in Ireland.

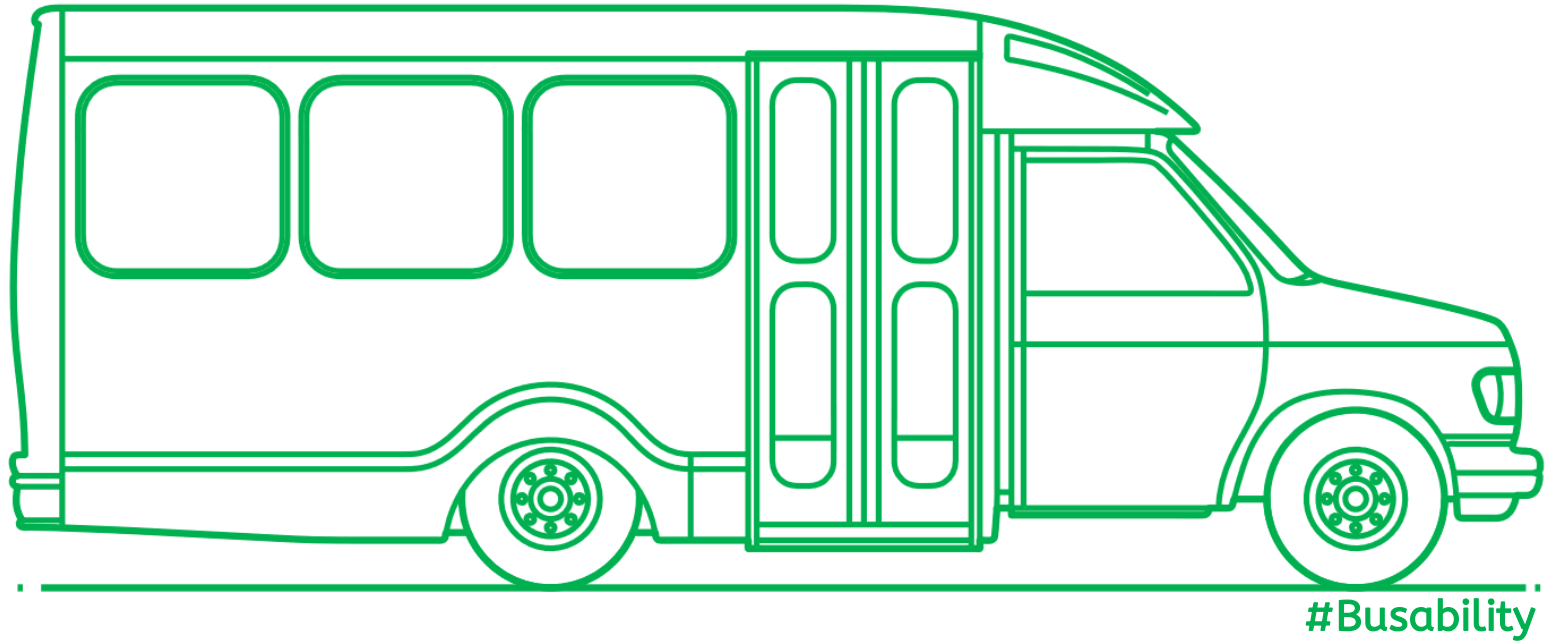

Mini-Buses or Shuttle Buses

Mini-buses or shuttle buses, are vehicles with passenger capacities below the larger full-size bus and more than a smaller mini-vans. This type of bus is used where there is a smaller demand and is often used for rural school transport schemes. This type of bus can seat up to **16 passengers**

| Bus Dimensions | | |
|----------------|------------------------|-------|
| Height | 8ft 9" | 2.67m |
| Width | 7ft 4" | 2.24m |
| Length | 23ft | 7.01m |
| Capacity | 16 (Seated) 0 Standing | |

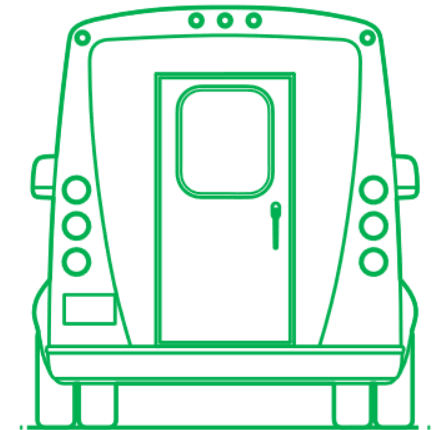
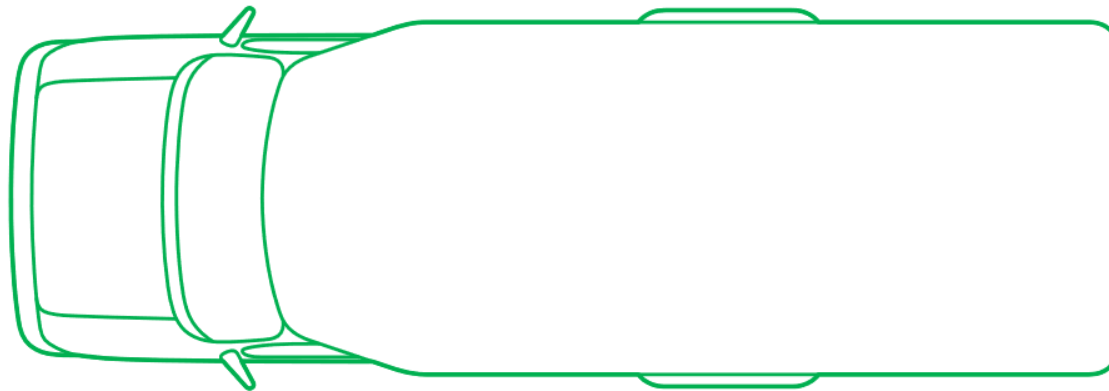
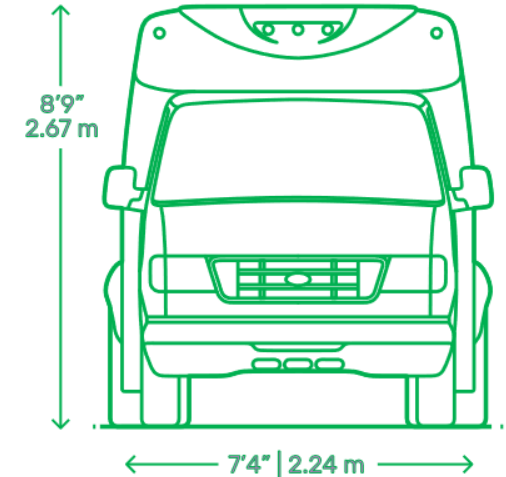
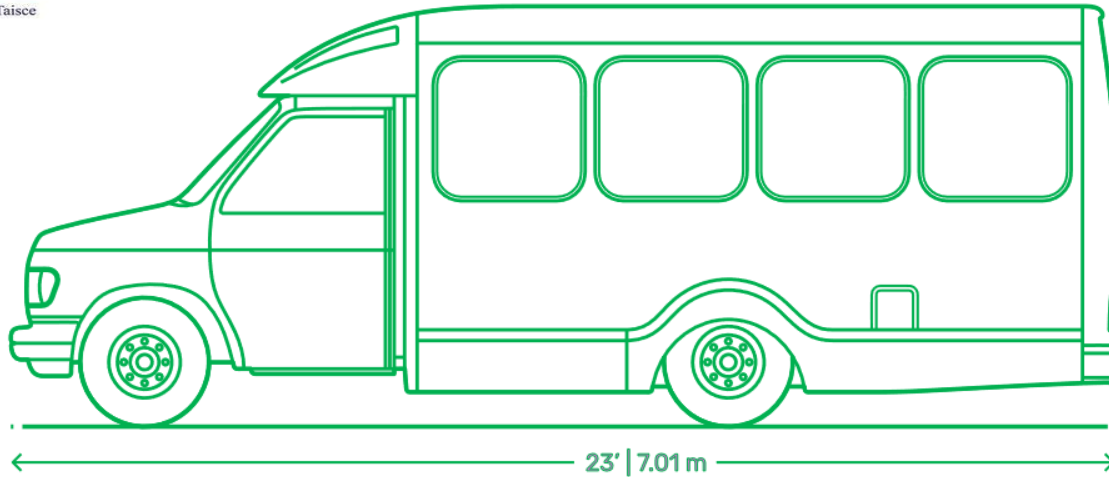

#Busability

Mini-Buses or Shuttle Buses

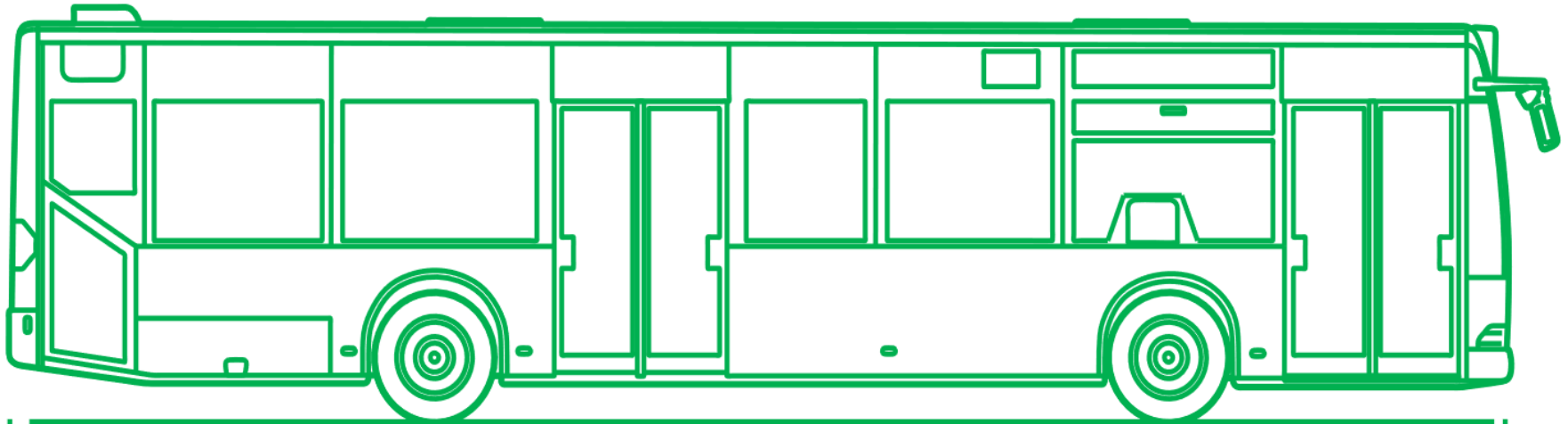

#Busability

City Transit Bus

City Buses or ‘transit’ buses are types of buses used for short to medium distance trips. These are designed to maximise capacity for rush-hour demands and are therefore equipped with simple seats and have multiple doors, pull cords and passenger information systems. They also have low-floors for greater accessibility. City transit buses can seat up to 30 with standing room for 76

| Bus Dimensions | | |
|----------------|-------------------------|--------|
| Height | 9.10ft | 2.99m |
| Width | 8.4ft | 2.55m |
| Length | 39.2ft | 11.95m |
| Capacity | 30 (Seated) 76 Standing | |

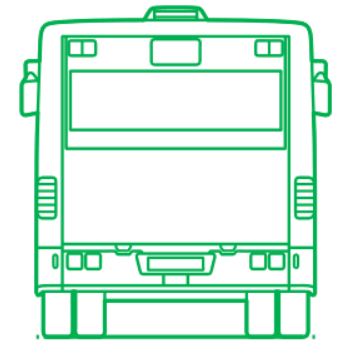
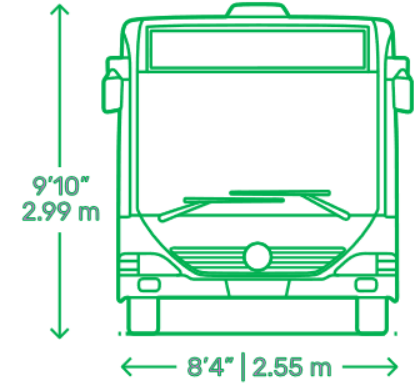
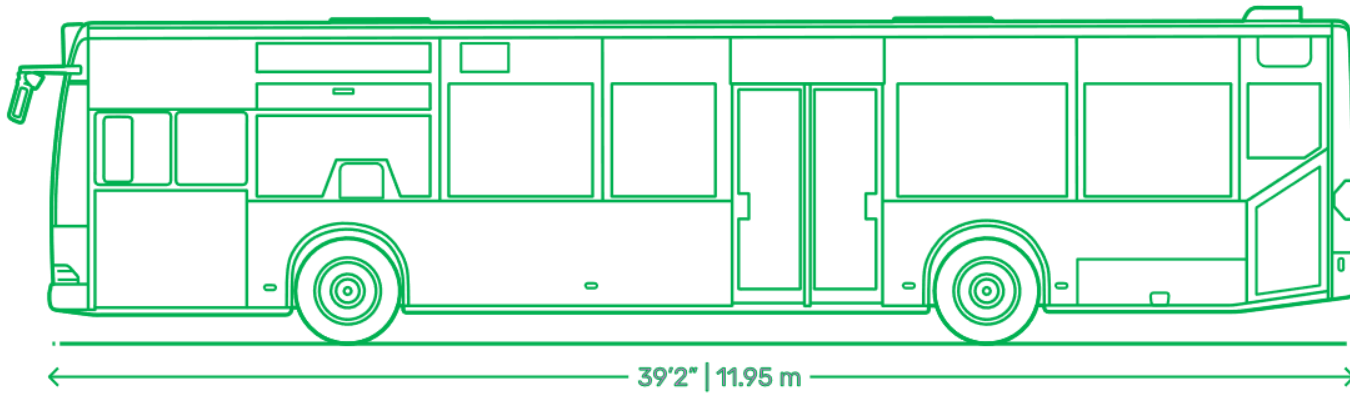

#Busability

City Transit Bus

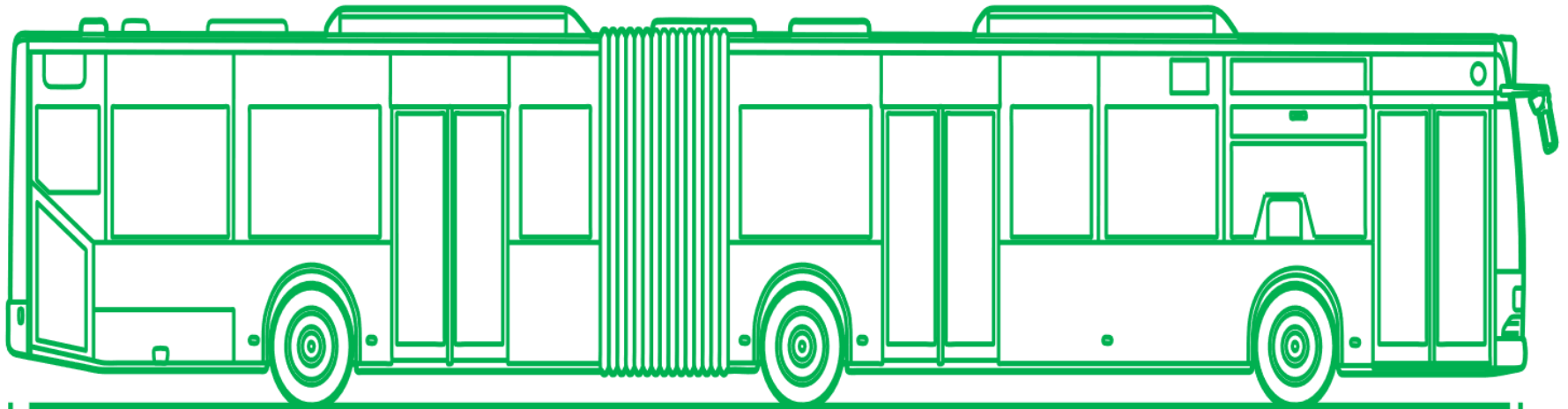

#Busability

Articulated Buses

Articulated buses are used in large cities where there is a high demand for public transport. They are extended buses which link together two or more sections. This type of bus is like a city transit bus with multiple doors and basic seating and can carry up to 49 seated passengers and 98 standing passengers.

Bus Dimensions

| | | |
|----------|-----------------------------|-------|
| Height | 10.4ft | 3.13m |
| Width | 8.5ft | 2.55m |
| Length | 59ft | 18m |
| Capacity | 48 + 1 (Seated) 98 Standing | |

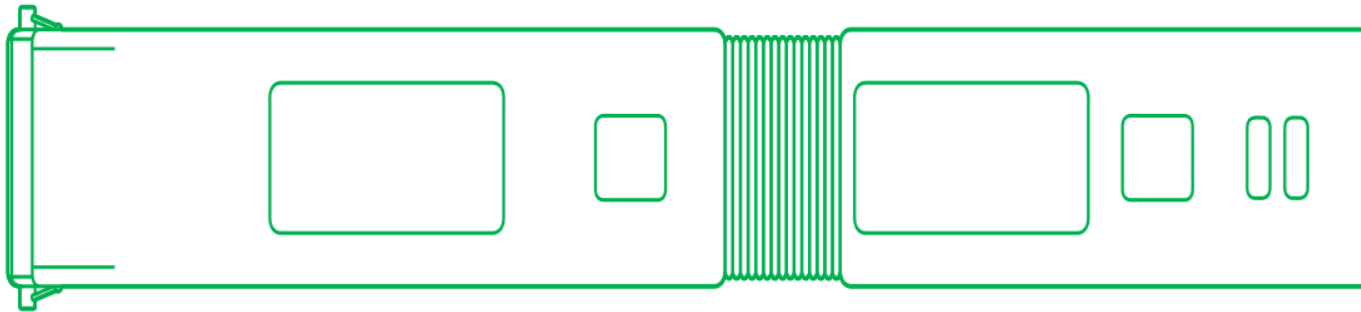
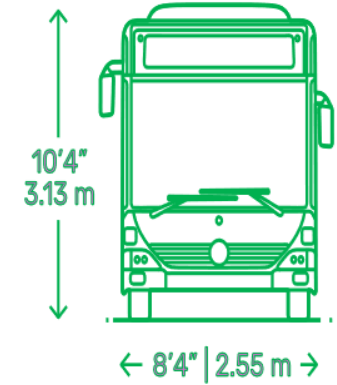
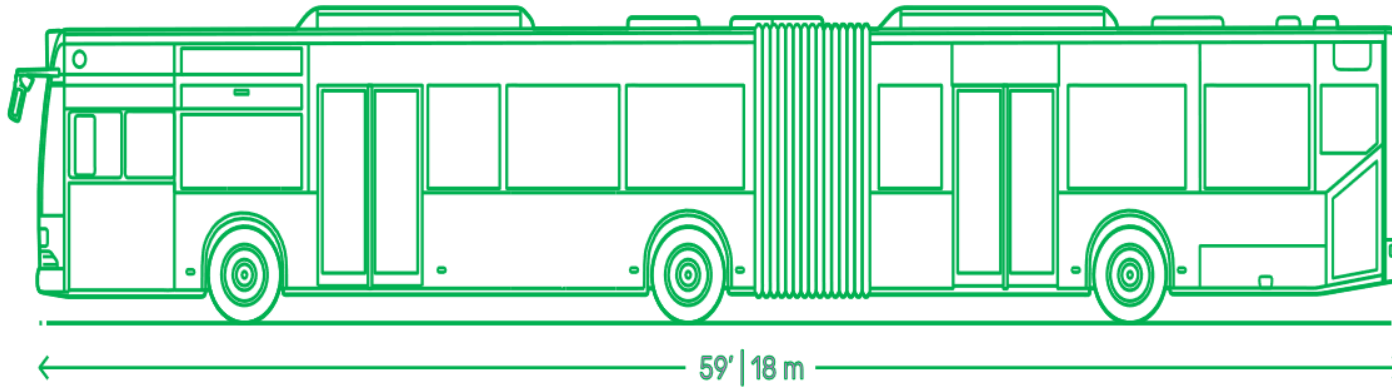

#Busability

Articulated Buses

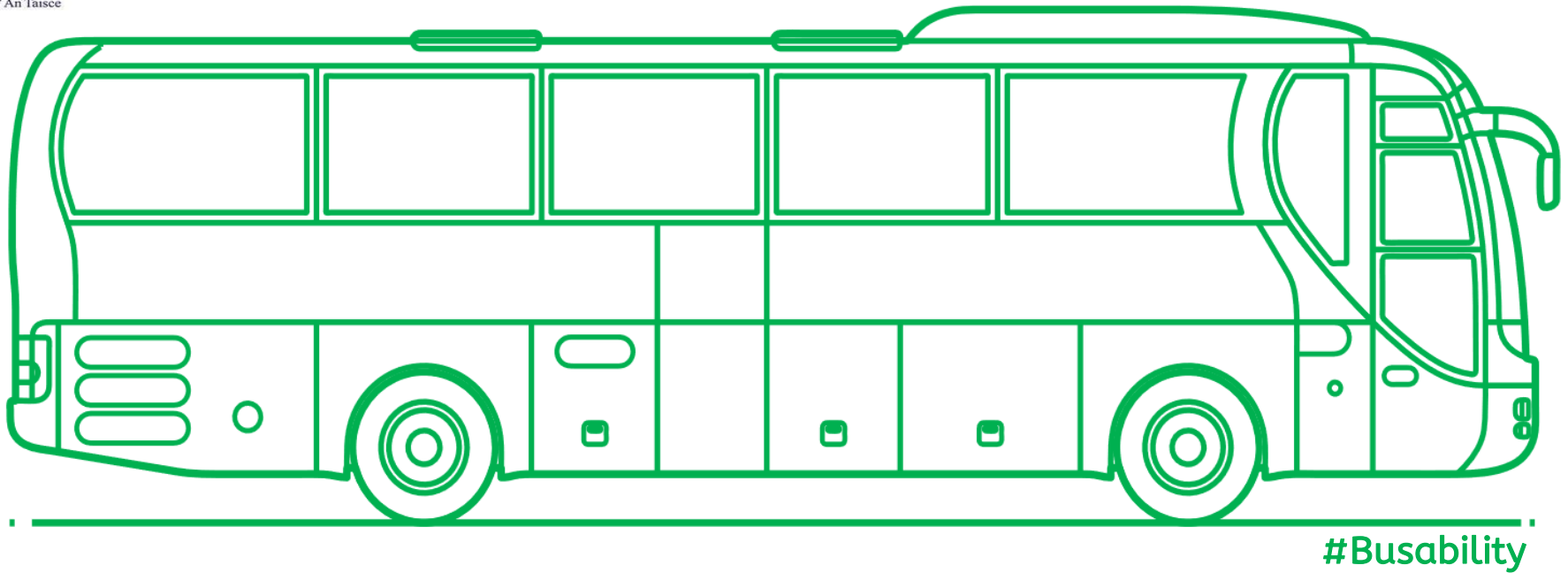

Coach Buses

This type of bus is designed specifically for longer journeys for example between major cities. This type of bus has comfortable seating, space for baggage, toilets, curtains and may have wi-fi. Coach buses can seat up to **49** passengers

| Bus Dimensions | | |
|----------------|------------------------|-------|
| Height | 12ft 6" | 3.81m |
| Width | 8ft 4" | 2.55m |
| Length | 39.4ft | 12m |
| Capacity | 49 (Seated) 0 Standing | |

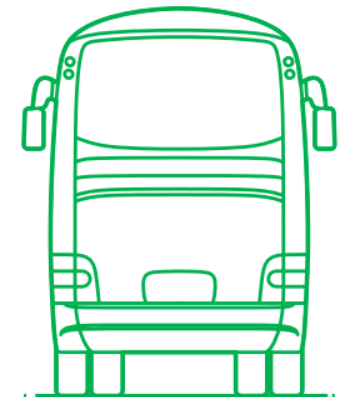
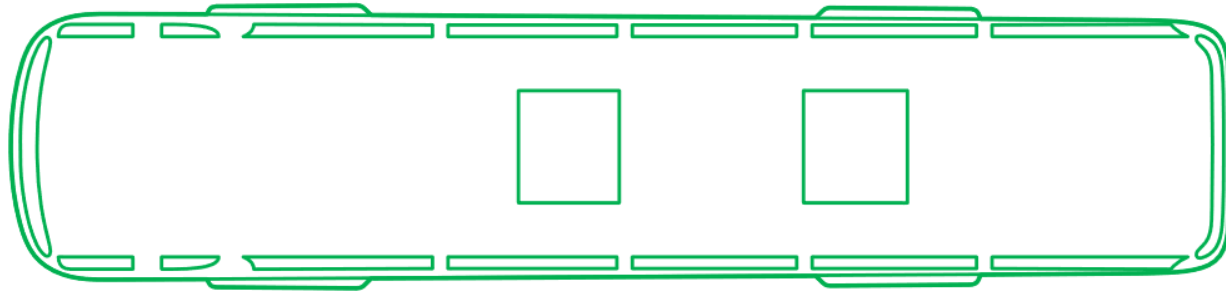
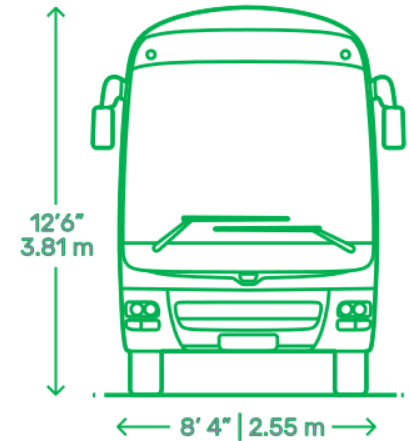
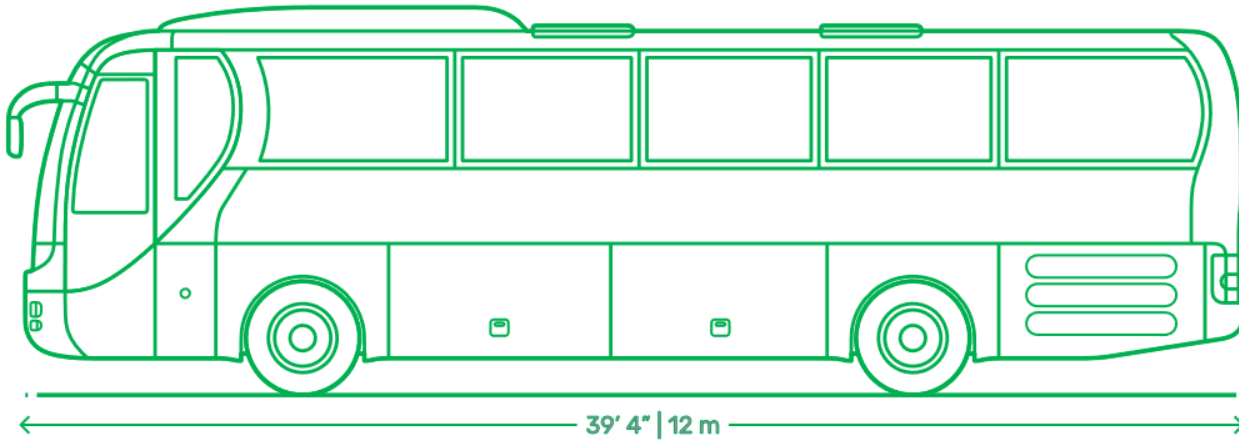

#Busability

Coach Buses